

Network Keyboard User Manual

Manual Version: V1.00

Disclaimer and Safety Warnings

Copyright Statement

©2023 Zhejiang Uniview Technologies Co., Ltd. All rights reserved.

No part of this manual may be copied, reproduced, translated or distributed in any form or by any means without prior consent in writing from Zhejiang Uniview Technologies Co., Ltd (referred to as Uniview or us hereafter).

The product described in this manual may contain proprietary software owned by Uniview and its possible licensors. Unless permitted by Uniview and its licensors, no one is allowed to copy, distribute, modify, abstract, decompile, disassemble, decrypt, reverse engineer, rent, transfer, or sublicense the software in any form or by any means.

Trademark Acknowledgements

 are trademarks or registered trademarks of Uniview.

All other trademarks, products, services and companies in this manual or the product described in this manual are the property of their respective owners.

Export Compliance Statement

Uniview complies with applicable export control laws and regulations worldwide, including that of the People's Republic of China and the United States, and abides by relevant regulations relating to the export, re-export and transfer of hardware, software and technology. Regarding the product described in this manual, Uniview asks you to fully understand and strictly abide by the applicable export laws and regulations worldwide.

Privacy Protection Reminder

Uniview complies with appropriate privacy protection laws and is committed to protecting user privacy. You may want to read our full privacy policy at our website and get to know the ways we process your personal information. Please be aware, using the product described in this manual may involve the collection of personal information such as face, fingerprint, license plate number, email, phone number, GPS. Please abide by your local laws and regulations while using the product.

About This Manual

- This manual is intended for multiple product models, and the photos, illustrations, descriptions, etc, in this manual may be different from the actual appearances, functions, features, etc, of the product.
- This manual is intended for multiple software versions, and the illustrations and descriptions in this manual may be different from the actual GUI and functions of the software.
- Despite our best efforts, technical or typographical errors may exist in this manual. Uniview cannot be held responsible for any such errors and reserves the right to change the manual without prior notice.
- Users are fully responsible for the damages and losses that arise due to improper operation.
- Uniview reserves the right to change any information in this manual without any prior notice or indication. Due to such reasons as product version upgrade or regulatory requirement of relevant regions, this manual will be periodically updated.

Disclaimer of Liability

- To the extent allowed by applicable law, in no event will Uniview be liable for any special, incidental, indirect, consequential damages, nor for any loss of profits, data, and documents.
- The product described in this manual is provided on an "as is" basis. Unless required by applicable law, this manual is only for informational purpose, and all statements, information, and recommendations in this manual are presented without warranty of any kind, expressed or implied, including, but not limited to, merchantability, satisfaction with quality, fitness for a particular purpose, and noninfringement.
- Users must assume total responsibility and all risks for connecting the product to the Internet, including, but not limited to, network attack, hacking, and virus. Uniview strongly recommends that users take all necessary measures to enhance the protection of network, device, data and personal information. Uniview disclaims any liability related thereto but will readily provide necessary security related support.
- To the extent not prohibited by applicable law, in no event will Uniview and its employees, licensors, subsidiary, affiliates be liable for results arising out of using or inability to use the product or service, including, not limited to, loss of profits and any other commercial damages or losses, loss of data, procurement of substitute goods or services; property damage, personal injury, business interruption, loss of business information, or any special, direct, indirect, incidental, consequential, pecuniary, coverage, exemplary, subsidiary losses, however caused and on any theory of liability, whether in contract, strict liability or tort (including negligence or otherwise) in any way out of the use of the product, even if Uniview has been advised of the possibility of such damages (other than as may be required by applicable law in cases involving personal injury, incidental or subsidiary damage).
- To the extent allowed by applicable law, in no event shall Uniview's total liability to you for all damages for the product described in this manual (other than as may be required by applicable law in cases involving personal injury) exceed the amount of money that you have paid for the product.

Network Security

Please take all necessary measures to enhance network security for your device.

The following are necessary measures for the network security of your device:

- **Change default password and set strong password:** You are strongly recommended to change the default password after your first login and set a strong password of at least nine characters including all three elements: digits, letters and special characters.

- **Keep firmware up to date:** It is recommended that your device is always upgraded to the latest version for the latest functions and better security. Visit Uniview's official website or contact your local dealer for the latest firmware.
- The following are recommendations for enhancing network security of your device:**
- **Change password regularly:** Change your device password on a regular basis and keep the password safe. Make sure only the authorized user can log in to the device.
 - **Enable HTTPS/SSL:** Use SSL certificate to encrypt HTTP communications and ensure data security.
 - **Enable IP address filtering:** Allow access only from the specified IP addresses.
 - **Minimum port mapping:** Configure your router or firewall to open a minimum set of ports to the WAN and keep only the necessary port mappings. Never set the device as the DMZ host or configure a full cone NAT.
 - **Disable the automatic login and save password features:** If multiple users have access to your computer, it is recommended that you disable these features to prevent unauthorized access.
 - **Choose username and password discretely:** Avoid using the username and password of your social media, bank, email account, etc, as the username and password of your device, in case your social media, bank and email account information is leaked.
 - **Restrict user permissions:** If more than one user needs access to your system, make sure each user is granted only the necessary permissions.
 - **Disable UPnP:** When UPnP is enabled, the router will automatically map internal ports, and the system will automatically forward port data, which results in the risks of data leakage. Therefore, it is recommended to disable UPnP if HTTP and TCP port mapping have been enabled manually on your router.
 - **SNMP:** Disable SNMP if you do not use it. If you do use it, then SNMPv3 is recommended.
 - **Multicast:** Multicast is intended to transmit video to multiple devices. If you do not use this function, it is recommended you disable multicast on your network.
 - **Check logs:** Check your device logs regularly to detect unauthorized access or abnormal operations.
 - **Physical protection:** Keep the device in a locked room or cabinet to prevent unauthorized physical access.
 - **Isolate video surveillance network:** Isolating your video surveillance network with other service networks helps prevent unauthorized access to devices in your security system from other service networks.

Learn More

You may also obtain security information under Security Response Center at Uniview's official website.

Safety Warnings

The device must be installed, serviced and maintained by a trained professional with necessary safety knowledge and skills. Before you start using the device, please read through this guide carefully and make sure all applicable requirements are met to avoid danger and loss of property.

Storage, Transportation, and Use

- Store or use the device in a proper environment that meets environmental requirements, including and not limited to, temperature, humidity, dust, corrosive gases, electromagnetic radiation, etc.
- Make sure the device is securely installed or placed on a flat surface to prevent falling.
- Unless otherwise specified, do not stack devices.
- Ensure good ventilation in the operating environment. Do not cover the vents on the device. Allow adequate space for ventilation.
- Protect the device from liquid of any kind.
- Make sure the power supply provides a stable voltage that meets the power requirements of the device. Make sure the power supply's output power exceeds the total maximum power of all the connected devices.
- Verify that the device is properly installed before connecting it to power.
- Do not remove the seal from the device body without consulting Uniview first. Do not attempt to service the product yourself. Contact a trained professional for maintenance.
- Always disconnect the device from power before attempting to move the device.
- Take proper waterproof measures in accordance with requirements before using the device outdoors.

Power Requirements

- Install and use the device in strict accordance with your local electrical safety regulations.
- Use a UL certified power supply that meets LPS requirements if an adapter is used.
- Use the recommended cordset (power cord) in accordance with the specified ratings.
- Only use the power adapter supplied with your device.
- Use a mains socket outlet with a protective earthing (grounding) connection.
- Ground your device properly if the device is intended to be grounded.

Contents

Disclaimer and Safety Warnings	i
1 Introduction	1
2 Web Operation	1
2.1 Web Login and User Management	1
2.1.1 Web Login and Logout	1
2.1.2 User	2
2.2 System	4
2.2.1 TCP/IP	4
2.2.2 Serial	5
2.2.3 Time	5
2.2.4 Security	6
2.3 Access Management	7
2.3.1 IPC	7
2.3.2 NVR	11
2.3.3 Decoder/Platform	12
2.4 System Maintenance	13
2.4.1 Device Status	13
2.4.2 Packet Capture	13
2.4.3 System Upgrade & Maintenance	14
3 Keyboard Operation	15
3.1 Keyboard Introduction	15
3.1.1 Appearance	15
3.1.2 Keys	16
3.2 Keyboard Login	17
3.3 System Configuration	18
3.3.1 Keyboard Configuration	18
3.3.2 Advanced Configuration	20
3.4 Mode Select	24
3.4.1 IPC Mode	24
3.4.2 NVR Control Mode	25
3.4.3 Decoder/Platform Mode	29

1 Introduction

KB1000-E is a new generation network keyboard developed independently by our company (referred as “keyboard” in the following), compatible with Uniview NVRs, network PTZ cameras, decoders, VMs, VMSs, and other devices. You can perform various functions with the joystick and keys on the keyboard. It can be used in both small and large application scenarios such as corporate parks, factories, and universities.

This manual introduces the operations of keyboard’s Web interface and local interface, helping you better configure and use the keyboard.

**NOTE!**

- This manual applies to multiple products, and the actual interfaces displayed on the Web interface and local interface may be different from those in this manual.
 - The RS232, RS485, and USB interfaces are reserved but not described in this manual.
-

2 Web Operation

2.1 Web Login and User Management

Please make sure that the keyboard operates properly and has network connectivity with the computer.

2.1.1 Web Login and Logout

1. Web Login

1. Open a browser on the computer, enter the keyboard IP address (default: 192.168.1.14, configurable in [TCP/IP](#) in the Web interface or [Network Configuration](#) in the local interface), and then press **Enter** to enter the **Login** page.

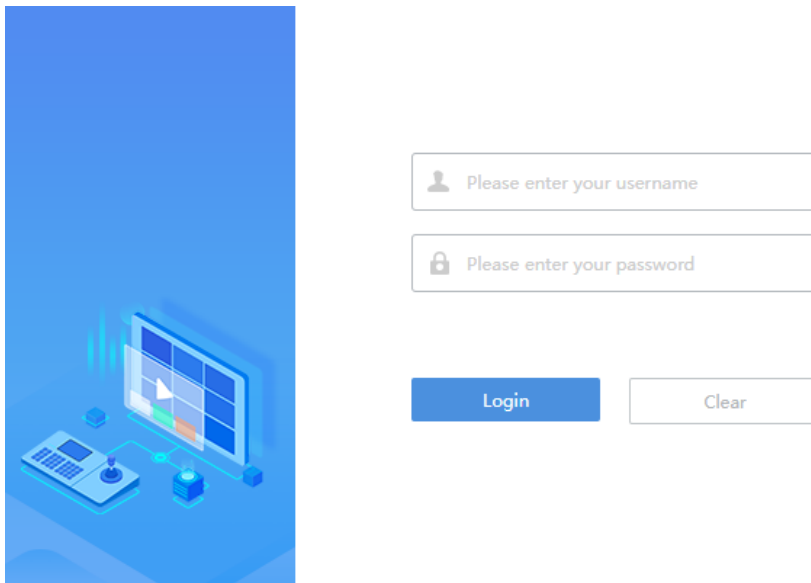

2. Enter the username and password (default: admin/123456), and then click **Login**.



NOTE!

- For security concerns, please change the default password promptly. See operations in [Change Password](#) in the Web interface or [User Management](#) in the local interface.
- Please make sure to remember the changed password. If you forget the password, press and hold the RST button on the keyboard for at least 5 seconds to restore factory defaults. Then use the default password (123456) to log in.

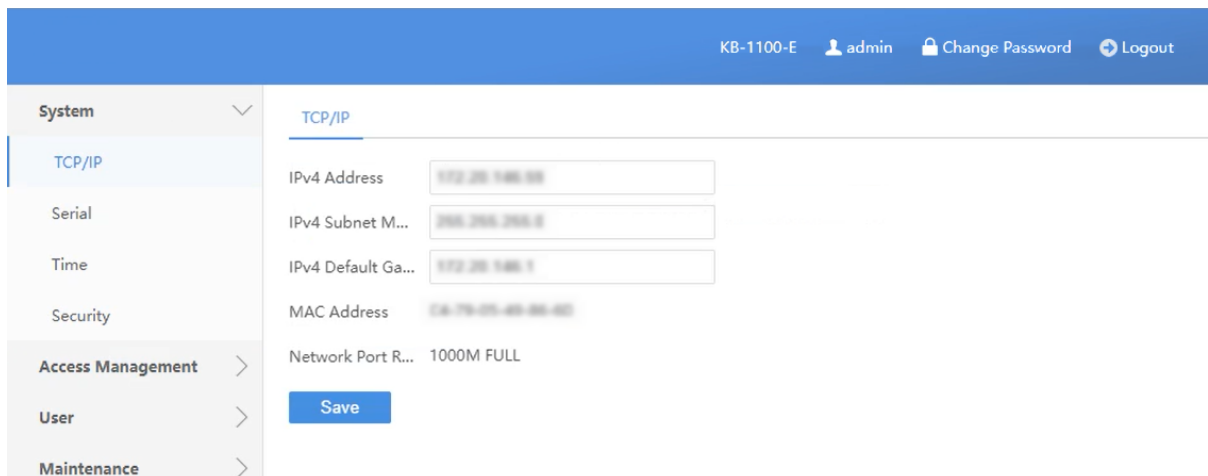

2. Logout

Click **Logout** in the top right corner of the Web interface. Then click **Confirm** in the pop-up window to log out.

2.1.2 User

Go to **User > User**. You can view and manage the user information.

- **admin**: The administrative user has all permissions such as keyboard configuration, user management, device control, and can log in to both the Web and local interface.
- **operator (non-admin user)**: The operation user has some permissions such as device control, and can only log in to the local interface.

User

+ Add Delete

	Username	User Type	Operation
<input type="checkbox"/>	admin	admin	🔒

1. Add User

1. Click **Add**. A page as shown below appears.

Add User ×

Username:

User Type:

Password:

Confirm Password:

2. Enter the user information, and then click **Confirm** to add the user.

User

+ Add Delete

	Username	User Type	Operation
<input type="checkbox"/>	admin	admin	🔒
<input type="checkbox"/>	1	Operator	🔒 🗑️

2. Change Password

1. Click  for the user in the **Operation** column. A page as shown below appears.

Reset Password ×

Password:

Confirm Password:

2. Enter and confirm the new password, and then click **Confirm** to change the password.
After changing the password, please use the new password for login next time.

To change the password for the login user (admin), click **Change Password** in the top right corner of the Web interface.

Change Password
✕

Username

Old Password

New Password

Confirm Password

Confirm
Cancel

3. Delete User

You can delete users one by one or in batches, but admin cannot be deleted.

- Delete one by one: Click for the user in the **Operation** column, and confirm the deletion in the pop-up window by clicking **Confirm**.
- Delete in batches: Select multiple users or all users, click **Delete**, and confirm the deletion in the pop-up window by clicking **Confirm**.

User

+ Add
 Delete

	Username	User Type	Operation
<input type="checkbox"/>	admin	admin	🔒
<input checked="" type="checkbox"/>	1	Operator	🔒

2.2 System

2.2.1 TCP/IP

Go to **System > TCP/IP**. You can view and edit the network information for the keyboard to ensure that the keyboard can communicate with other devices properly.

TCP/IP

IPv4 Address

IPv4 Subnet M...

IPv4 Default Ga...

MAC Address

Network Port R... 1000M FULL

Save

Item	Description
IPv4 Address	View or edit the IP address. You can log in to the Web interface via the IP address. NOTE: If you set a weak password consisting only of digits or letters, you cannot change the IP address across the network segments.
IPv4 Subnet Mask	Set the IPv4 subnet mask, which divides an IP into the network and host address and determines the host subnet size.

Item	Description
IPv4 Default Gateway	Set the IPv4 default gateway for the host of the local subnet to connect and communicate with the external network.
MAC Address	View the MAC address, which is a unique identifier assigned to network interfaces for communications on a physical network.
Network Port Rate	View the actual network speed of the device.

2.2.2 Serial

Reserved.

2.2.3 Time

Go to **System > Time**. You can set the keyboard time.

Time

Time Zone

System Time Sync with PC

Auto Update On Off

Save

Item	Description
Time Zone	Choose a time zone for the keyboard.
System Time	<ul style="list-style-type: none"> Set manually: Click <input type="text"/> after the System Time, set the date and time manually, and then click Confirm to save the settings. Auto sync: Select Sync with PC checkbox to sync the keyboard time with the PC time.

If there is a Network Time Protocol (NTP) server in the system, you can enable **Auto Update** and configure the NTP server to sync the keyboard time with the standard time. When **Auto Update** is enabled, the parameters set in **Time Zone** and **System Time** are invalid.



NOTE!

Network Time Protocol (NTP) server provides accurate time synchronization service.

Time

Time Zone: (GMT+08:00) Beijing, Hong Kong ▾

System Time: 2023-11-7 04:02:20 PM Sync with PC

Auto Update: On Off

NTP Server Ad...: 0.0.0.0

NTP Port: 123

Update Interval: 5 Mins ▾

Save

Item	Description
NTP Server Address	Enter the IP address of the NTP server.
NTP Port	Enter the port number of the NTP server.
Update Interval	Set an interval for automatic time synchronization.

2.2.4 Security

1. Telnet

Go to **System > Security > Telnet**. You can enable or disable Telnet as needed. Telnet establishes a remote connection with the device, allowing you to access and control the device remotely, which helps with troubleshooting and device upgrades.



NOTE!

- Telnet is a network protocol commonly used for remote login services on the Internet, which allows you to remotely access the keyboard's local client on the computer.
- Telnet's username/password is root/123456.

Telnet Authentication

Telnet: On Off

Save

2. Authentication

Go to **System > Security > Authentication**. You can set the login authentication method.



NOTE!

- Authentication verifies user's permission to access and operate the system.
- HTTP authentication allows users to provide a username and password for authentication via the Hypertext Transfer Protocol (HTTP).

Telnet **Authentication**

HTTP Digest

Save

Item	Description
HTTP	<ul style="list-style-type: none"> ● Null: The username and password will not be encrypted. ● Digest: Digest authentication provides more security to basic authentication. It encrypts the username and password with random numbers for transmitting to avoid disclosure.

2.3 Access Management

When devices such as IPCs, NVRs, and VMs are on the same LAN as the keyboard and have network connectivity, they can be connected to the keyboard for unified management. You can view the live videos of the connected devices and control them on the keyboard. See more operations in [Mode Select](#) in the local interface.

2.3.1 IPC

When you add IPCs to the system, each IPC is automatically assigned a channel ID in sequence. You can select and control the IPCs on the keyboard by selecting the channel ID, and can also control the PTZ camera to rotate and zoom. See more operations in [IPC Mode](#) in the local interface.

1. IPC Management

Go to **Access Management > IPC Mode > Device Info**. You can view and edit the IPC information, and also click **Refresh** to refresh the device list. The newly added IPC channels will be automatically displayed in the **Channel** page.

Device Info Channel

Managed device(s)(0) Auto Search + Add Delete Refresh

	IP Address	Device Type	Protocol	Model	Online Status	Operation
<input type="checkbox"/>						

Add Device

Choose a way to add devices.



NOTE!

If the device username or password entered is incorrect, it can also be displayed in the device list, but the status is offline and cannot be operated.

- Auto Search

(1) Click **Auto Search**. A page as shown below appears.

The system automatically searches for devices that are on the same LAN as the keyboard. You can also set the IP address and management status as needed for precise searching.

Auto Search

+ Batch Add IP Address: 0.0.0.0 - 0.0.0.0 Status: All Device Type: IPC Search

<input type="checkbox"/>	Status	IP Address	Port	Device Type	Model	Protocol	Serial No.	Operation
<input type="checkbox"/>	no	172.20.146.207	80	IPC	HIC6821-IRL@F200-TT	ONVIF	210235C76K0755905777	+
<input type="checkbox"/>	no	172.20.146.202	80	IPC	HIC6881-X22IR	ONVIF	210235C2813178000025	+
<input type="checkbox"/>	no	172.20.146.78	80	IPC	IPC-B2A2-IR@P-IR3-F60-C	ONVIF	210235C34E3185000016	+
<input type="checkbox"/>	no	172.20.146.215	80	IPC	DS-8864N-R8(C)	ONVIF	210235C2813178000027	+
<input type="checkbox"/>	no	172.20.146.202	80	IPC	HIC5421HI-L-US	ONVIF	210235C34E3185000096	+
<input type="checkbox"/>	no	172.20.146.78	80	IPC	HC131@GMV-L32S	ONVIF	210235C2813178000035	+
<input type="checkbox"/>	no	172.20.146.206	80	IPC	HIC68441-FW@X41-F40-L-VH	ONVIF	210235C6BN3234000167	+
<input type="checkbox"/>	no	172.20.146.206	80	IPC	HIC8581-IRE4@DH-L-GB	ONVIF	210235C38T3236000026	+
<input type="checkbox"/>	no	172.20.146.202	80	IPC	HIC28441-WH@X4-F40-VH1	ONVIF	210235C6BN3234000567	+
<input type="checkbox"/>	no	172.20.146.207	80	IPC	HIC6821-IRL@F200-TT	ONVIF	210235C76K0755905776	+

View 1 - 12 of 12 20 Page 1 of 1

(2) Add IPCs to the keyboard one by one or in batches. If multiple devices share the same username and password, you can add devices in batches.

- Add one by one: Click + for the device. A page as shown below appears. Enter the device information and click **Confirm** to add the device.

Add Device

Protocol: ONVIF

Transmission Protocol: TCP

Device Type: IPC

IP: 172.20.146.78

Port: 80

Username:

Password:

Confirm Cancel

- Add in batches: Select multiple devices or all devices and click **Batch Add**. A page as shown below appears. Enter the device information and click **Confirm** to add the selected devices.

Device Info
✕

Protocol:

Transmission Protocol:

Username:

Password:

- Add Directly

Click **Add**. A page as shown below appears. Enter the device information and click **Confirm** to add the device.

Add Device
✕

Protocol:

Transmission Protocol:

Device Type:

IP:

Port:

Username:

Password:

Edit Device

Edit the information of the added devices.

If the device is offline due to wrong device information, after correcting the device information, the device can be reconnected and its status will switch to online.

Device Info
Channel

Managed device(s)(3)

	IP Address	Device Type	Protocol	Model	Online Status	Operation
<input type="checkbox"/>	192.168.1.100	IPC	ONVIF	HIC5421 HI-L-US	■ Online	
<input type="checkbox"/>	192.168.1.101	IPC	ONVIF	IPC-B2A2-IR@P-IR3-F60-C	■ Incorrect username or password	
<input type="checkbox"/>	192.168.1.102	IPC	ONVIF	HIC28441-WH@X4-F40-VH1	■ Offline	

1. Click for the device. A page as shown below appears.

Edit
✕

Protocol:

Transmission Protocol:

Device Type:

IP:

Port:

Username:

Password:

2. Edit the device information as needed and then click **Confirm** to save the settings.

Device Info		Channel				
Managed device(s)(3)						
<input type="text" value="Auto Search"/> <input type="button" value="+ Add"/> <input type="button" value="Delete"/> <input type="button" value="Refresh"/>						
<input type="checkbox"/>	IP Address	Device Type	Protocol	Model	Online Status	Operation
<input type="checkbox"/>	192.168.1.100	IPC	ONVIF	HIC5421HI-L-US	Online	<input type="button" value="Edit"/> <input type="button" value="Delete"/> <input type="button" value="Refresh"/>
<input type="checkbox"/>	192.168.1.101	IPC	ONVIF	IPC-B2A2-IR@P-IR3-F60-C	Online	<input type="button" value="Edit"/> <input type="button" value="Delete"/> <input type="button" value="Refresh"/>
<input type="checkbox"/>	192.168.1.102	IPC	ONVIF	HIC28441-WH@X4-F40-VH1	Offline	<input type="button" value="Edit"/> <input type="button" value="Delete"/> <input type="button" value="Refresh"/>

Delete Device

You can delete devices one by one or in batches.

- Delete one by one: Click for the device in the **Operation** column, and confirm the deletion in the pop-up window by clicking **Confirm**.
- Delete in batches: Select multiple devices or all devices, click **Delete**, and confirm the deletion in the pop-up window by clicking **Confirm**.

Device Info		Channel				
Managed device(s)(3)						
<input type="text" value="Auto Search"/> <input type="button" value="+ Add"/> <input type="button" value="Delete"/> <input type="button" value="Refresh"/>						
<input type="checkbox"/>	IP Address	Device Type	Protocol	Model	Online Status	Operation
<input type="checkbox"/>	192.168.1.100	IPC	ONVIF	HIC5421HI-L-US	Online	<input type="button" value="Edit"/> <input type="button" value="Delete"/> <input type="button" value="Refresh"/>
<input checked="" type="checkbox"/>	192.168.1.101	IPC	ONVIF	IPC-B2A2-IR@P-IR3-F60-C	Online	<input type="button" value="Edit"/> <input type="button" value="Delete"/> <input type="button" value="Refresh"/>
<input type="checkbox"/>	192.168.1.102	IPC	ONVIF	HIC28441-WH@X4-F40-VH1	Offline	<input type="button" value="Edit"/> <input type="button" value="Delete"/> <input type="button" value="Refresh"/>

2. IPC Channel Management

Go to **Access Management > IPC Mode > Channel**. You can view and manage the IPC channels, and also click **Refresh** to refresh the channel list.

The channel ID is unique and cannot be duplicated. You can select and control the IPCs on the keyboard by selecting the channel ID.

The channel number indicates the channel sequence number of the corresponding IPC.

Device Info **Channel**

Refresh

<input type="checkbox"/>	Channel ID	IP Address	Channel No.	Channel Name	Device Model	Status	Operation
<input type="checkbox"/>	1	172.20.146.200	1	172.20.146.200_1(172.20.146.200)	HIC5421HI-L-US	Online	
<input type="checkbox"/>	2	172.20.146.76	1	172.20.146.76_1(172.20.146.76)	IPC-B2A2-IR@P-IR3-F60-C	Online	
<input type="checkbox"/>	3	172.20.146.200	1	172.20.146.200-1_1(172.20.146.200)	HIC28441-WH@X4-F40-VH1	Offline	
<input type="checkbox"/>	4	172.20.146.200	2	HIC28441-WH@X4-F40-VH1_172.20.146.200_2	HIC28441-WH@X4-F40-VH1	Offline	

Click for the channel. A page as shown below appears. Edit the channel information as needed and then click **Confirm** to save the settings.

Edit ✕

Channel ID:

Channel Name:

2.3.2 NVR

Go to **Access Management > NVR Control Mode**. You can add and manage NVR devices. When adding NVR devices, enter the NVR ID (unique and cannot be duplicated) manually. You can select and control the NVR’s local interface on the keyboard by selecting the NVR ID.

NVR

+ Add

<input type="checkbox"/>	Device ID	Device Name	Access Mode	IP Address	Port	Serial Port	Operation
--------------------------	-----------	-------------	-------------	------------	------	-------------	-----------

To control the IPCs under NVR, you can view the IPC channel ID in NVR’s Web interface. Then you can control the IPC on the keyboard by selecting the IPC channel ID, and perform actions such as PTZ control. See more operations in [NVR Control Mode](#) in the local interface.

1. Add Device

1. Click **Add**. A page as shown below appears.

Add Device ✕

Device ID:

Device Name:

Access Mode: ▼

IP:

Port:

2. Enter the device information and then click **Confirm**.

NVR

+ Add Delete

<input type="checkbox"/>	Device ID	Device Name	Access Mode	IP Address	Port	Serial Port	Operation
<input type="checkbox"/>	1	1	Network	192.168.1.101	60000		
<input type="checkbox"/>	2	2	Network	192.168.1.102	60000		

2. Edit Device

Click for the device. A page as shown below appears. Edit the device information as needed and then click **Confirm** to save the settings.

Edit ✕

Device ID:

Device Name:

Access Mode: ▼

IP:

Port:

3. Delete Device

You can delete devices one by one or in batches.

- Delete one by one: Click for the device in the **Operation** column, and confirm the deletion in the pop-up window by clicking **Confirm**.
- Delete in batches: Select multiple devices or all devices, click **Delete**, and confirm the deletion in the pop-up window by clicking **Confirm**.

NVR

+ Add Delete

<input type="checkbox"/>	Device ID	Device Name	Access Mode	IP Address	Port	Serial Port	Operation
<input type="checkbox"/>	1	1	Network	192.168.1.101	60000		
<input checked="" type="checkbox"/>	2	2	Network	192.168.1.102	60000		

2.3.3 Decoder/Platform

Go to **Access Management > Decoder/Platform Mode**. Enter the information of a decoding device (decoder, distributed device, video wall controller) or a platform (VM, VMS, EZStation), and then click **Save** to save the settings.

When connected with EZStation, please enter the information of the computer where EZStation is installed.

When connected with a platform, please also add and configure the keyboard information on the platform.

Decoder/Platform Mode

Access Mode

IP Address

Port

For different decoders or platforms, you can view the IDs of video walls, IPCs, sequences, single-window sequences under the connected decoder/platform in different ways. By selecting the ID on the keyboard, you can control them and perform actions such as playing live video on the wall and controlling PTZ. See more operations in [Decoder/Platform Mode](#) in local interface.

2.4 System Maintenance

2.4.1 Device Status

Go to **Maintenance > Device Status**. You can view device's basic information and running status, and also click **Refresh** to get the latest information.

Device Status

Basic Info

Model	KB-1100-E
Serial No.	210235C7LM3239000004
Firmware Version	2023.11.02.0001
Hardware Versi...	A
Boot Version	GRUB 2.02

Running Status

System Time	2023/11/07 16:02:35
Running Time	0 Day(s) 4 Hour(s) 48 Minute(s)
Temperature	57°C
CPU Usage	4%
Memory Usage	27%

2.4.2 Packet Capture

Go to **Maintenance > Packet Capture**. The system can capture the packets between the keyboard and other devices, which can be used for troubleshooting.

1. Enter the IP address and port number of the device to capture packets.

Packet Capture

IP Address

Port

Start **Stop**

2. Click **Start** to start the packet capture process and click **Stop** to stop it.



NOTE!

- When the IP address is empty, the system will capture all data packets interacting with the keyboard.
- The packet capture process will automatically stop when the packet size exceeds 20MB.

2.4.3 System Upgrade & Maintenance

Go to **Maintenance > Maintenance**. You can upgrade and maintain the system.

Maintenance

Restart	Restart device
Default	Keep the current network and user settings and restore other settings to factory defaults.
Export	Export configuration file
Export	Export diagnostic information
Auto Restart	Never <input type="text"/> 00:00 <input type="text"/> OK
Configurations	<input type="text"/> Import
Local Upgrade	<input type="text"/> Upgrade

Note: Do not disconnect power or perform any other operation during upgrade.

Item	Description
Restart	Restart the keyboard.
Default	Restore all factory default settings except the network and user settings and restart the keyboard.
Export Configuration	Export, view, and save the configuration information.
Export Diagnostic Information	Export, view, and save the diagnostic information.
Auto Restart	Select the frequency and time for automatic restart and click OK to save the settings.
Import Configurations	Click and a pop-up window appears. Select the configuration file from local and click Import , the keyboard will restart automatically after the completion.
Local Upgrade	Click and a pop-up window appears. Select the upgrade file from local and click Upgrade , then restart the keyboard for the upgrade to take effect. Note: <ul style="list-style-type: none"> • Do not disconnect power or perform any other operations during the device upgrade and maintenance process. • Degrading the version is not supported.

3 Keyboard Operation

3.1 Keyboard Introduction

3.1.1 Appearance

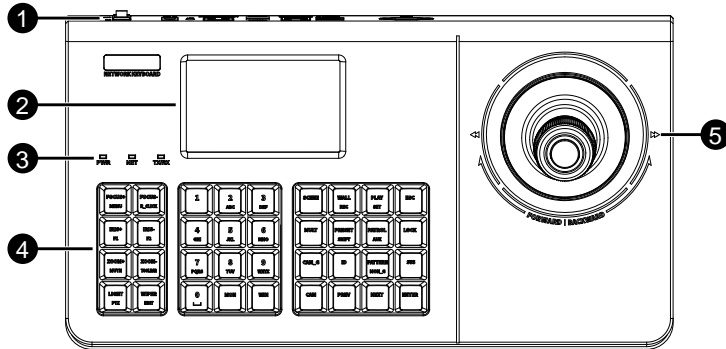

No.	Name	Description
1	Interfaces	Connect to other devices and network.
2	Screen	Display menus, messages, etc.
3	Indicator	<p>Display the status of the keyboard.</p> <ul style="list-style-type: none"> ● PWR (Power) <ul style="list-style-type: none"> ➢ Steady on: Start up or in normal operation. ➢ Off: The device is powered off. ● NET (Network) <ul style="list-style-type: none"> ➢ Steady on: Connected to network. ➢ Off: No network connection. ● TX/RX (Serial port) <ul style="list-style-type: none"> ➢ Blinking: Transmitting data. ➢ Off: No data transmission.
4	Keys	Control PTZ and video wall. See operations in Mode Select
5	Joystick	<p>Tilt/rotate the joystick</p> <ul style="list-style-type: none"> ● Main screen: Tilt up/down/left/right to navigate between menu items. ● PTZ screen: Rotate to adjust the PTZ direction. ● Playback screen: <ul style="list-style-type: none"> ➢ Tilt up/down: Forward/rewind the playback. ➢ Tilt left/right: Adjust playback speed. <p>Press the top button</p> <ul style="list-style-type: none"> ● Once: <ul style="list-style-type: none"> ➢ Confirm. ➢ Pause/resume playback. ● Twice (with interval of no more than 0.3 seconds): NVR snapshot. <p>Rotate the bottom knob</p> <ul style="list-style-type: none"> ● Clockwise: <ul style="list-style-type: none"> ➢ ZOOM+, zoom in on the image. ➢ Forward playback for 30s. ● Anticlockwise: <ul style="list-style-type: none"> ➢ ZOOM-, zoom out on the image. ➢ Rewind playback for 30s.

3.1.2 Keys

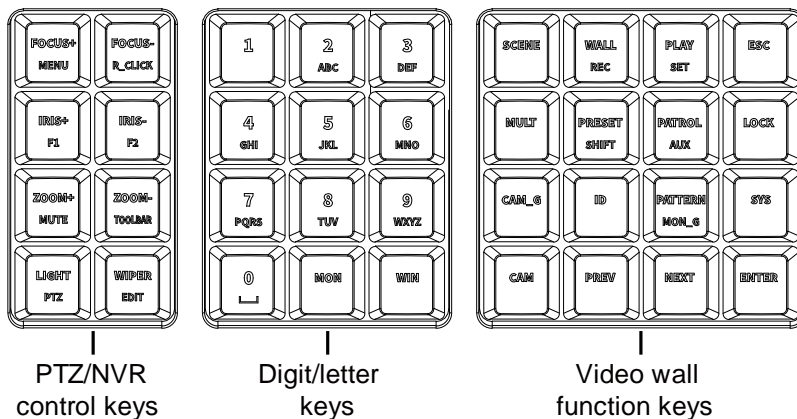

Key Type	Mode 1	Mode 2
PTZ (mode 1)/NVR (mode 2) control keys	FOCUS+/- : Increase/decrease camera focus	MENU: NVR menu R_CLICK: Right-click
	IRIS+/- : Increase/decrease camera iris	F1: Navigate between menu items F2: Switch tabs
	ZOOM+/- : Zoom in/out	MUTE: Turn off audio TOOLBAR: Toolbar
	LIGHT: Light	-
	WIPER: Wiper	Edit: Edit
	PTZ (function switch key): Switch to PTZ control mode ESC: Return to NVR control mode	
Digit/letter keys (press SHIFT to switch)	0-9: Digit	A-Z: Letter _: Space
	MON: Select window	-
	WIN: Select split window	-
Video wall function keys	SCENE: Switch scene (reserved)	-
	WALL: Select video wall	REC: Recording (reserved)
	PLAY: Playback	SET: Set
	ESC: Exit	-
	MULT: Split window	-
	PRESET: Configure/call preset	SHIFT (function switch key): Switch digits/lowercase letters/uppercase letters
	PATROL: Call preset patrol	AUX: Expansion functions (reserved)
	LOCK: Lock the keyboard screen	-
	CAM_G: Call sequence	-
	ID: Select the device/channel to control	-
PATTERN: Call recorded patrol	MON_G: Call multi-window sequence (reserved)	

Key Type	Mode 1	Mode 2
	SYS: Home screen	-
	CAM: Select camera	-
	PREV: Switch to the previous image	-
	NEXT: Switch to the next image	-
	ENTER: Confirm	-

3.2 Keyboard Login

1. When the keyboard is started up successfully, you will see “Control Keyboard” on the screen.

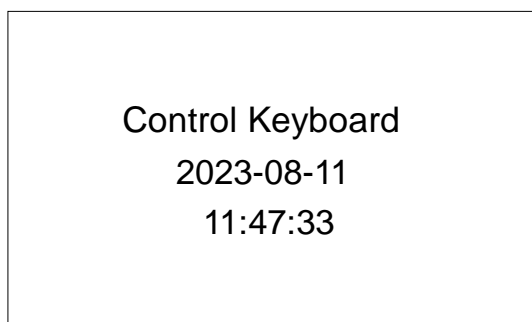

2. Press ENTER/joystick's top button once to enter the **Login** screen.

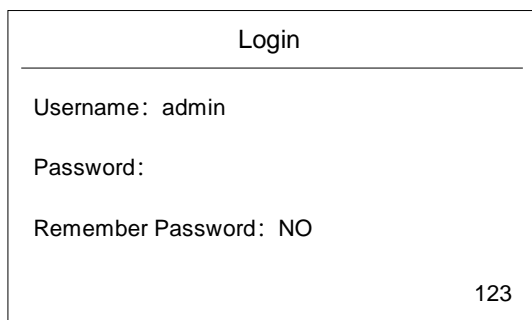

3. Tilt the joystick up/down to switch items, enter the username and password, and then press ENTER/joystick's top button once to enter the **Menu** screen. (Press ESC to return to the **Login** screen.)
 - Username: Tilt the joystick left/right to switch between different users. You can add users in [User](#) in the Web interface or [User Management](#) in the local interface.
The admin is the administrative user who can configure the keyboard, manage users, and control devices; the operator is the non-admin user who can only control devices.
 - Password:
 - To enter the password, press the digit/letter keys. Use the SHIFT key to switch between digits and letters. The current mode is displayed in the bottom right corner of the screen. Each key contains 3 letters, and you can press the key multiple times to switch to a different letter.
 - Tilt the joystick left once to delete one character of the password. Tilt the joystick left for at least 2 seconds to clear all characters.

- Remember Password: Tilt the joystick left/right to switch between **YES** and **No**.

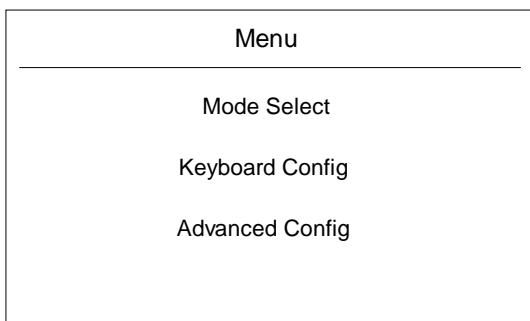

3.3 System Configuration

3.3.1 Keyboard Configuration

On the **Menu** screen, tilt the joystick up/down to **Keyboard Config**, and then press ENTER/joystick's top button once to enter the screen. (Press ESC to return to the **Menu** screen.)

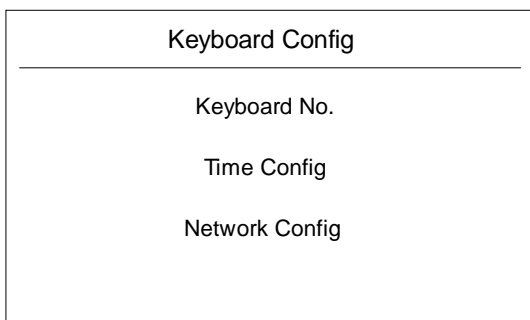

1. Keyboard Number

On the **Keyboard Config** screen, tilt the joystick up/down to **Keyboard No.**, and then press ENTER/joystick's top button once to view the keyboard ID. (Press ESC to return to the **Keyboard Config** screen.)

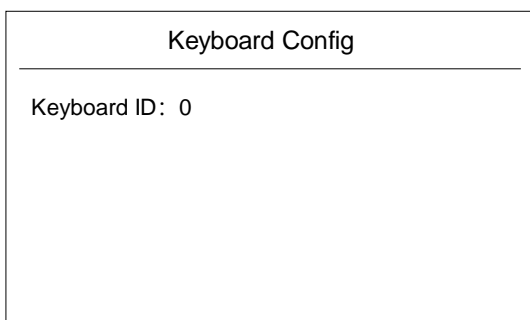

2. Time Configuration

On the **Keyboard Config** screen, tilt the joystick up/down to **Time Config**, and then press ENTER/joystick's top button once to view and edit the keyboard time. (Press ESC to return to the **Keyboard Config** screen.)

Time Config
Date: <u>2</u> 023-08-11
Time: 11:47:33

1. Tilt the joystick up/down to switch items, tilt the joystick left/right to move the cursor, and then press the digit key to edit the keyboard time.

Time Config
Date: 2023-08-1 <u>2</u>
Time: 11:47:33

2. Press ENTER/joystick's top button once to save the settings and return to the **Keyboard Config** screen. (Press ESC to cancel the changes and return to the **Keyboard Config** screen.)

3. Network Configuration

On the **Keyboard Config** screen, tilt the joystick up/down to **Network Config**, and then press ENTER/joystick's top button once to view and edit the keyboard's network settings. (Press ESC to return to the **Keyboard Config** screen.)

Network Config
IP: <u>1</u> 92.168.1.14
Mask: 255.255.255.0
Gateway: 192.168.1.1

1. Tilt the joystick up/down to switch items, tilt the joystick left/right to move the cursor, and then press the digit key to edit the keyboard network settings.

Network Config
IP: 192.168.1. <u>15</u>
Mask: 255.255.255.0
Gateway: 192.168.1.1

2. Press ENTER/joystick's top button once to save the settings and return to the **Keyboard Config** screen. (Press ESC to cancel the changes and return to the **Keyboard Config** screen.)

3.3.2 Advanced Configuration

On the **Menu** screen, tilt the joystick up/down to **Advanced Config**, and then press ENTER/joystick's top button once to enter the screen. (Press ESC to return to the **Menu** screen.)

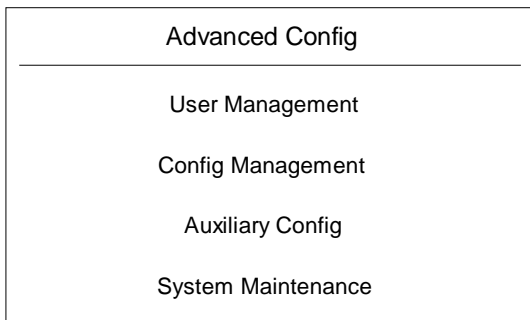

1. User Management

On the **Advanced Config** screen, tilt the joystick up/down to **User Management**, and then press ENTER/joystick's top button once to add and manage users. (Press ESC to return to the **Advanced Config** screen.)

- admin: The administrative user has all permissions such as keyboard configuration, user management, device control, and can log in to both the Web and local interface.
- operator (non-admin user): The operation user has some permissions such as device control, and can only log in to the local interface..

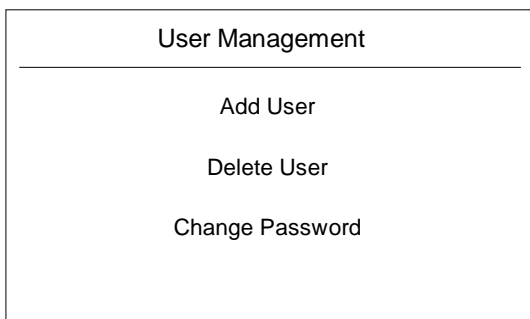

Add User

1. Tilt the joystick up/down to **Add User**, and then press ENTER/joystick's top button once to enter the screen.

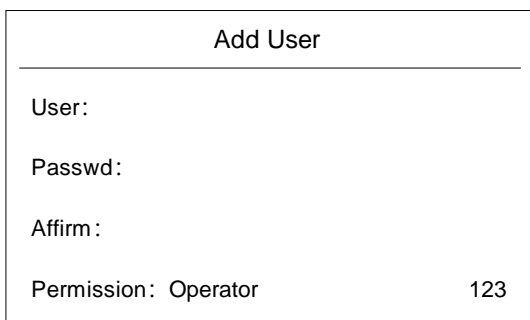

2. Tilt the joystick up/down to switch items, enter the user information, and then press ENTER/joystick's top button once to add a new user and return to the **User Management** screen. (Press ESC to cancel the changes and return to the **User Management** screen.)
 - User/Password/Password affirmation
 - To enter the password, press the digit/letter keys. Use the SHIFT key to switch between digits and letters. The current mode is displayed in the bottom right corner of the screen. Each key contains 3 letters, and you can press the key multiple times to switch to a different letter.
 - Tilt the joystick left once to delete one character of the password. Tilt the joystick left for at least 2 seconds to clear all characters.
 - Permission: Operator only.

Change Password

After changing the password, please use the new password for login next time.

1. Tilt the joystick up/down to **Change Password**, and then press ENTER/joystick's top button once to enter the screen.

Change Password	
User: admin	
O_Passwd:	
N_Passwd:	
Affirm:	123

2. Tilt the joystick up/down to switch items, change the password as needed, and then press ENTER/joystick's top button once to return to the **User Management** screen. (Press ESC to cancel the changes and return to the **User Management** screen.)
 - Username: Tilt the joystick left/right to switch users.
 - Old password/New password/Password affirmation
 - To enter the password, press the digit/letter keys. Use the SHIFT key to switch between digits and letters. The current mode is displayed in the bottom right corner of the screen. Each key contains 3 letters, and you can press the key multiple times to switch to a different letter.
 - Tilt the joystick left once to delete one character of the password. Tilt the joystick left for at least 2 seconds to clear all characters.

Delete User

You cannot delete admin.

1. Tilt the joystick up/down to **Delete User**, and then press ENTER/joystick's top button once to enter the screen.

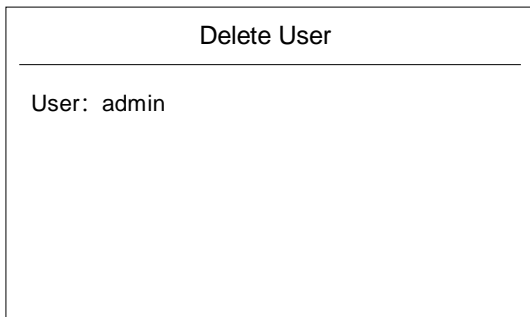

2. Tilt the joystick up/down to switch users, press ENTER/joystick's top button, and confirm the deletion by pressing again.

2. Configuration Management

Reserved.

3. Auxiliary Configuration

On the **Advanced Config** screen, tilt the joystick up/down to **Auxiliary Config**, and then press ENTER/joystick's top button once to set the keyboard lock time. (Press ESC to return to the **Advanced Config** screen.)

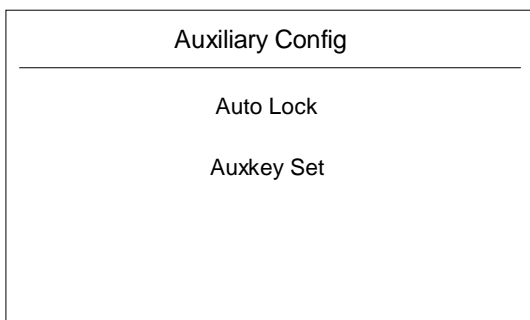

Auto Lock

1. Tilt the joystick up/down to **Auto Lock**, and then press ENTER/joystick's top button once to enter the screen.

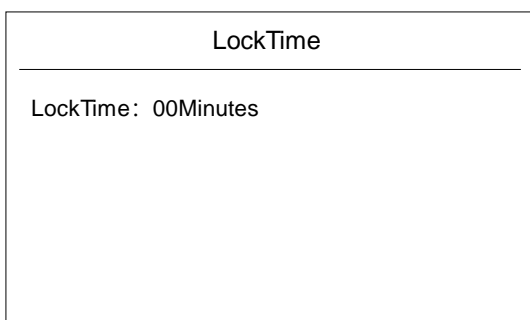

2. Press the digit key to set the lock time (unit: minute), and then press ENTER/joystick's top button once to save the settings and return to the **Auxiliary Config** screen. (Press ESC to cancel the changes and return to the **Auxiliary Config** screen.)
3. If you do not operate the keyboard for more than the set time or press the LOCK key, the keyboard will be locked. Press ENTER/joystick's top button once to unlock the keyboard.

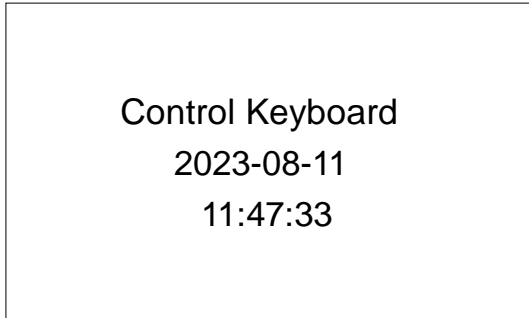

AuxKey Set

Reserved.

4. System Maintenance

On the **Advanced Config** screen, tilt the joystick up/down to **System Maintenance**, and then press ENTER/joystick's top button once to view the keyboard information and restore defaults. (Press ESC to return to the **Advanced Config** screen.)

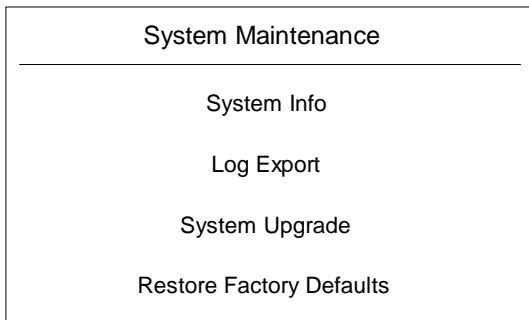

System Information

Tilt the joystick up/down to **System Info**, and then press ENTER/joystick's top button once to enter the screen. You can view the keyboard's hardware and software versions.

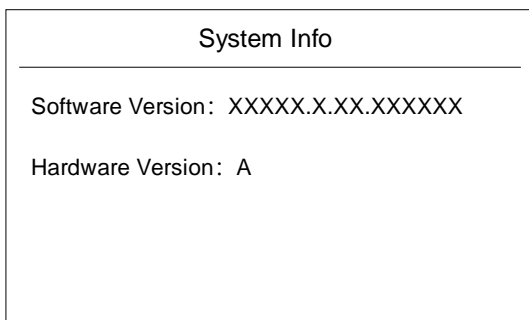

Log Export

Reserved.

System Upgrade

Reserved.

Restore Factory Defaults

On the **System Maintenance** screen, tilt the joystick up/down to **Restore Factory Defaults**, and then press ENTER/joystick's top button once to enter the screen. The system will keep the network and user settings and restore other settings to factory default. (Press ESC to return to the **System Maintenance** screen.) Then the keyboard will restart.

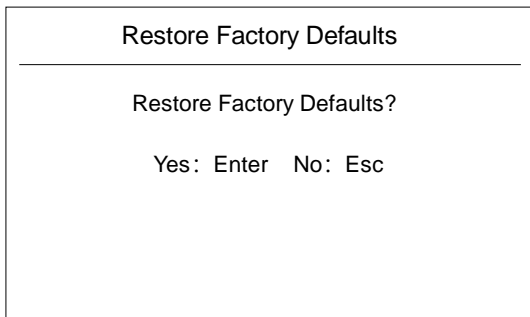

3.4 Mode Select

On the **Menu** screen, tilt the joystick up/down to **Mode Select**, and then press ENTER/joystick's top button once to enter the screen. (Press SYS to return to the **Menu** screen.)

By using the joystick and keys on the keyboard, you can control the connected devices and perform actions such as viewing the live video of the connected device, controlling the device. To connect devices with the keyboard, see operations in [Access Management](#) in the Web interface.

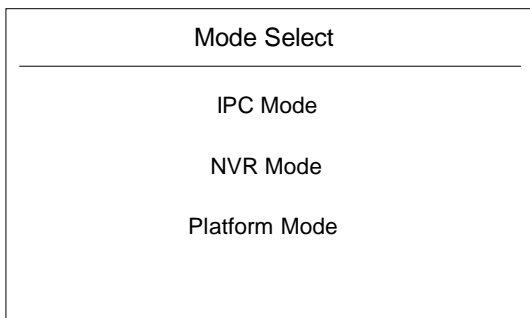

3.4.1 IPC Mode

On the **Mode Select** screen, tilt the joystick up/down to **IPC Mode**, and then press ENTER/joystick's top button once to enter the screen. (Press SYS to return to the **Menu** screen.)

In the IPC mode, you can use the joystick and keys to control the PTZ cameras connected on the Web interface (see access operations in Access Management > [IPC Mode](#)) and perform actions such as controlling the PTZ camera to rotate and zoom.

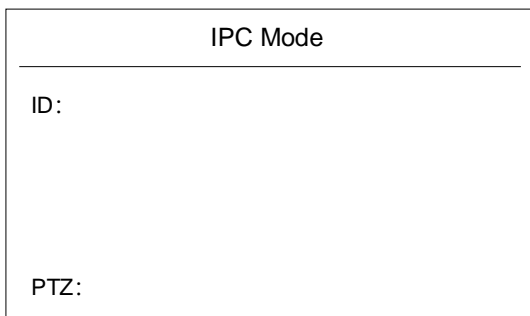

1. Select IPC

Press **IPC Channel ID+ID** to select the IPC. The steps are as follows:

1. Go to **Access Management > IPC Mode > Channel** in the Web interface to view the channel ID.

Device Info Channel

Refresh

Channel ID	IP Address	Channel No.	Channel Name	Device Model	Status	Operation
1	172.20.146.200	1	172.20.146.200_1(172.20.146.200)	HIC5421HI-L-US	Online	
2	172.20.146.76	1	172.20.146.76_1(172.20.146.76)	IPC-B2A2-IR@P-IR3-F60-C	Online	
3	172.20.146.200	1	172.20.146.200-1_1(172.20.146.200)	HIC28441-WH@X4-F40-VH1	Offline	
4	172.20.146.200	2	HIC28441-WH@X4-F40-VH1_172.20.146.200_2	HIC28441-WH@X4-F40-VH1	Offline	

2. Press the *channel ID* on the keyboard, and then press the ID key to select the channel.

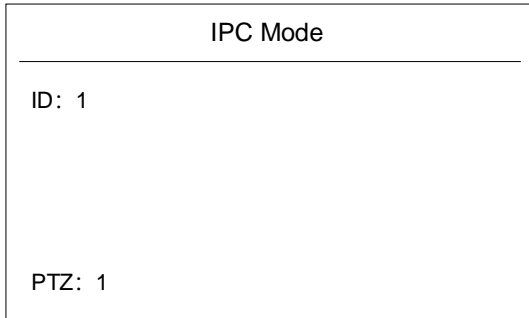

2. Control PTZ Camera

For PTZ cameras, you can control its rotation, zoom, and focus.

Operation	Function
Tilt the joystick in all directions	Control the rotation of the PTZ. The greater the joystick is tilted, the faster the PTZ rotates.
<ul style="list-style-type: none"> ● Rotate the bottom knob clockwise/anti-clockwise ● Press the ZOOM+/- key 	Zoom in/out. Adjust the camera lens to enlarge/reduce the image. In the IPC mode, the greater the angle of rotation the bottom knob, the faster the zoom speed.
Press the FOCUS+/- key	Increase/decrease the camera focus. Adjust the focusing distance to sharpen the distant/close image.

3.4.2 NVR Control Mode

On the **Mode Select** screen, tilt the joystick up/down to **NVR Control Mode**, and then press ENTER/joystick's top button once to enter the screen. (Press SYS to return to the **Menu** screen.)

In the NVR control mode, you can use the keys to control NVR's local interface directly and perform actions such as previewing the camera image and calling sequence (see more local client operations in NVR's user manual); you can also use the joystick and keys to control the PTZ cameras under NVR and perform actions such as controlling the PTZ camera to rotate and zoom.

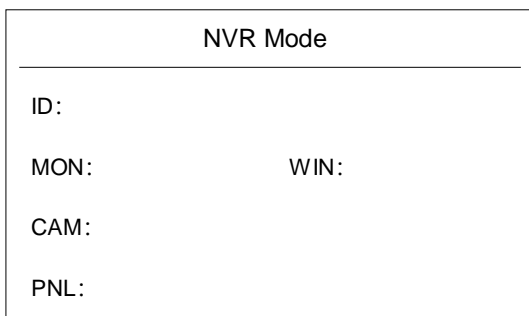

1. Select NVR

Press **NVR ID+ID** to select the NVR. The steps are as follows:

1. Go to **Access Management > NVR Control Mode** in the Web interface to view the NVR ID.

NVR

+ Add Delete

<input type="checkbox"/>	Device ID	Device Name	Access Mode	IP Address	Port	Serial Port	Operation
<input type="checkbox"/>	1	1	Network	192.168.1.101	60000		
<input type="checkbox"/>	2	2	Network	192.168.1.102	60000		

2. Press the **NVR ID** on the keyboard, and then press the ID key to select the NVR.

NVR Mode

ID: 1

MON: WIN:

CAM:

PNL:

2. Control NVR's Local Interface

After selecting the NVR, there will be a PNL in the lower left corner of the screen, then you can use the NVR control keys to control the NVR local interface. (Press PTZ to switch to the PTZ control mode, and the PNL will switch to PTZ; press ESC to return to PNL.)

Key	Function	Key	Function
MENU	Open the NVR menu	R_CLICK	Right-click
F1	Navigate between menu items	F2	Switch tabs
MUTE	Turn off audio	TOOLBAR	Tool bar
EDIT	Edit	Press joystick's top button twice	NVR snapshot
PREV	Switch to the previous image	NEXT	Switch to the next image
Press ENTER/joystick's top button once	Confirm	ESC	Exit/return to the previous screen
CAM_G	Press once to start sequence; press once again to stop sequence.		

3. Control PTZ Camera

After selecting the NVR, you can select the PTZ camera under NVR and perform actions such as rotating the PTZ camera, configuring/calling preset, and calling patrol.

Select PTZ Camera

Press **IPC Channel ID+CAM+PTZ** to select the PTZ camera under the NVR and enter the PTZ control mode. The steps are as follows:

1. Press the *channel ID* on the keyboard, and then press the CAM key to select the PTZ camera. You can view the channel ID in NVR's Web interface.

NVR Mode	
ID: 1	
MON:	WIN:
CAM: 1	
PNL:	

2. Press the PTZ key to switch to the PTZ control mode.

NVR Mode	
ID: 1	
MON:	WIN:
CAM: 1	
PTZ:	

Control PTZ Camera Operation

In the PTZ control mode, you can control the PTZ camera to rotate, zoom, and focus. For some models, you can perform other operations such as adjusting the iris, turning on light.

Operation	Function
Tilt the joystick in all directions	Control the rotation of the PTZ. The greater the joystick is tilted, the faster the PTZ rotates.
<ul style="list-style-type: none"> ● Rotate the bottom knob clockwise/anti-clockwise ● Press the ZOOM+/- key 	Zoom in/out. Adjust the camera lens to enlarge/reduce the image.
Press the FOCUS+/- key	Increase/decrease the camera focus. Adjust the focusing distance to sharpen the distant/close image.
Press the IRIS+/- key	Increase/decrease the camera iris. Adjust the iris size to brighten/darken the image.
Press the LIGHT key	Turn on the light to provide illumination at low light environment
Press the WIPER key	Turn on the wiper to remove obstructions from the lens

Configure Preset

In the PTZ control mode, press **SET+Preset No.+PRESET** to configure the preset. The steps are as follows:

1. Rotate the PTZ into the desired position, then press the SET key.
2. Press the digit key(s) to set the preset number.

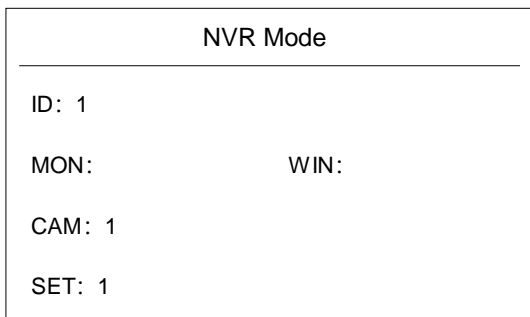

3. Press the PRESET key to set the position as a preset.

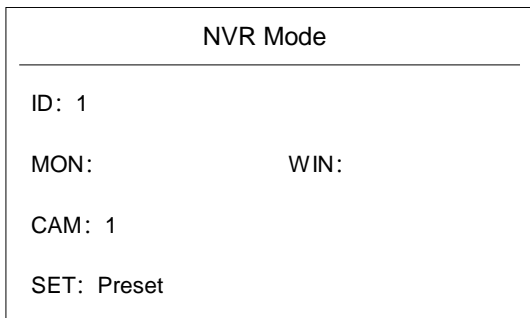

4. Press the SET/ESC key to exit.

Call Preset

Press **Preset No.+PRESET** to call the configured preset. The steps are as follows:

1. Press the configured *preset number*.

You can view the preset number in PTZ camera's Web interface.

2. Press the PRESET key to call the preset, then the PTZ will rotate to the configured position.

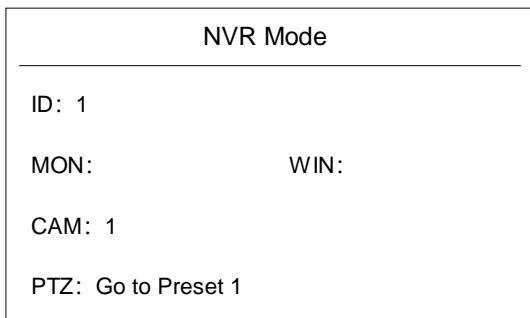

Call Patrol

In the PTZ control mode, press the configured preset patrol/pattern patrol number, press the PATROL/PATTERN key, and then the PTZ camera will patrol according to the schedule.

You can view the preset patrol and pattern patrol number in NVR's Web interface.

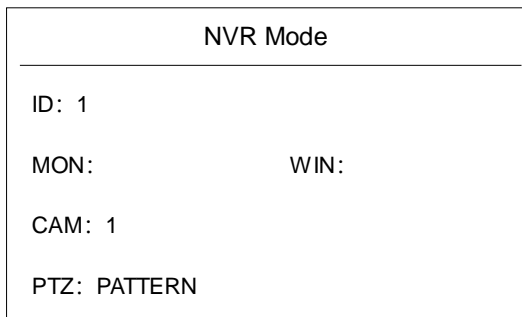
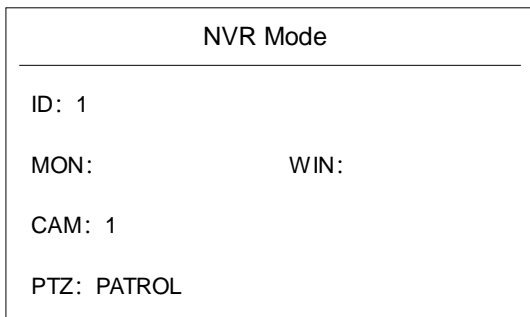

3.4.3 Decoder/Platform Mode

On the **Mode Select** screen, tilt the joystick up/down to **Platform Mode**, and then press ENTER/joystick's top button once to enter the screen. (Press SYS to return to the **Menu** screen.)

In the decoder/platform mode, you can directly control the window style of the video walls under the connected device, such as displaying the window border and restoring the window to its original size after zooming in/out. You can also control the IPCs under the connected device, such as playing IPC image on the wall, controlling the PTZ cameras, viewing playback, and playing sequence on the wall.

Platform Mode	
ID:	WALL:
MON:	WIN:
CAM:	
PNL:	

For different connected devices, you can view the ID of the video wall, IPC, sequence, and single-window sequence in different way, control them by selecting the ID, and perform actions such as playing live video on the wall and controlling PTZ.

- When connected with a decoding device: Decoding device is often used with EZWall, you can view the resource ID in EZWall. See operations in EZWall's user manual.
- When connected with VM/VMS: View the resource ID in the Web interface. See operations in VM/VMS's Web client user manual.
- When connected with EZStation: View the resource ID in the software interface. See operations in EZStation's user manual.

1. Select Video Wall

Press **1+ID+ Video Wall ID+WALL** to select the video wall. The steps are as follows:



NOTE!

After selecting the video wall, you can directly perform actions such as selecting window and playing IPC image on the wall without selecting it again.

1. Press the digit 1 and then press the ID key to select the connected device.

Platform Mode	
ID: 1	WALL:
MON:	WIN:
CAM:	
PNL:	

2. Press the *video wall ID*, and then press the WALL key to select the video wall.

Platform Mode	
ID: 1	WALL: 1
MON:	WIN:
CAM:	
PNL:	

2. Select Window/Split Window

After selecting the video wall, press **Window ID+MON+Split Window ID+WIN** to select the window/split window. The steps are as follows:



NOTE!

After selecting the window/split window on the video wall, you can directly perform actions such as playing IPC image on the wall and controlling the PTZ camera without selecting it again.

1. Press the *window ID*, and then press the MON key to select the window.

Windows and split windows are generally numbered in order from left to right, top to bottom.

You can enable window/split window ID display on the video wall in [Window Style](#).

Platform Mode	
ID: 1	WALL: 1
MON: 1	WIN:
CAM:	
PNL:	

2. If there are split windows in the window, you can press the *split window ID*, and then press the WIN key to select the split window. If there is no split window, select the whole window or split the window in advance (see operations in [Window Style](#)).

Platform Mode	
ID: 1	WALL: 1
MON: 1	WIN:
CAM:	
PNL:	

3. Play IPC Image on Wall

After selecting the window/split window, press **IPC No.+CAM** to select the IPC and play the IPC image on the wall. The steps are as follows:

1. Press the *IPC number* on the keyboard, and then press the CAM key to play the IPC image on the wall.

Platform Mode	
ID: 1	WALL: 1
MON: 1	WIN: 1
CAM: 1	
PNL:	

2. (Optional) Press PREV/NEXT to switch to the previous/next IPC image in the list.

Platform Mode	
ID: 1	WALL: 1
MON: 1	WIN: 1
CAM: 1	
PNL: Next Cam	



NOTE!

Priority level: ID>WALL>MON>WIN>CAM. After editing the upper level contents, the lower level contents will all be cleared.

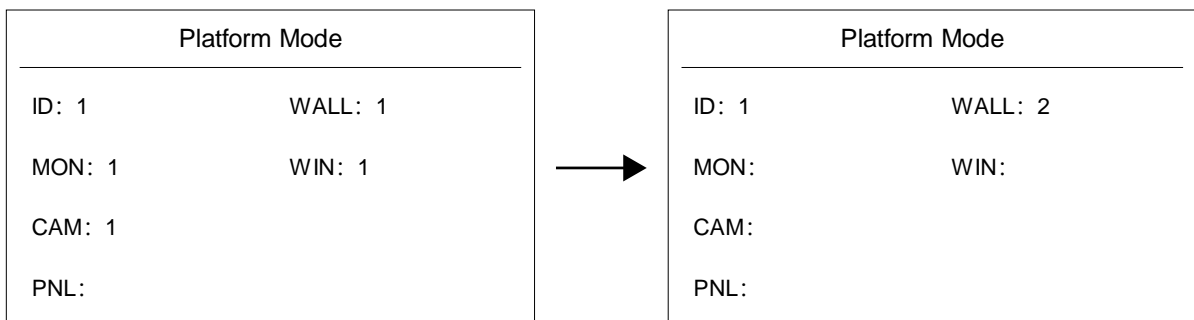

4. Control PTZ Camera

If you want to control the PTZ cameras under the connected device, select the window/split window, and then press **PTZ+PTZ Camera No.+CAM** to select the PTZ camera. Then the image will be played on the wall and you can also control the PTZ to perform actions such as rotation and zoom. The steps are as follows:

1. Press the PTZ key on the keyboard to switch to the PTZ control mode.

Platform Mode	
ID: 1	WALL: 1
MON: 1	WIN: 1
CAM:	
PTZ:	

2. Press the *PTZ camera number*, and then press the CAM key to select and control the PTZ camera.

When connected with decoding device used with EZWall, you can see the PTZ control operations in IPC Mode > [Control PTZ Camera](#); for other devices, see operations in NVR Mode > [Control PTZ Camera](#).

Platform Mode	
ID: 1	WALL: 1
MON: 1	WIN: 1
CAM: 1	
PTZ:	

5. View Playback

After playing the IPC image on the wall, if the IPC supports the playback function, press the PLAY key to view the playback. The steps are as follows:

When connected with VM/VMS, please configure storage/add storage schedule in the Web interface (see configuration operations in the corresponding Web client user manual) in advance.

1. Select the IPC device and press the PLAY key to enter the playback mode. (Press ESC to exit the playback mode.)

Platform Mode	
Date: 2023-08-11	
Time: 11:47:33	

2. Tilt the joystick up/down to switch items, tilt the joystick left/right to move the cursor, and then press the digit keys to set the playback time.

Platform Mode	
Date: 2023-08-10	
Time: 11:47:33	

3. Press ENTER/joystick's top button once to view the playback at the set time.

Platform Mode	
ID: 1	WALL: 1
MON: 1	WIN: 1
CAM: 1	
REP:	

When connected with VM, you can perform actions to the playback of the connected IPCs.

Operation	Function
Tilt the joystick up/down	Forward/rewind
Tilt the joystick left/right	Adjust playback speed <ul style="list-style-type: none"> ● Cycle through fast playback at 2x, 4x, 8x speed. ● Cycle through slow playback at 1/2x, 1/4x, 1/8x speed.
Rotate the bottom knob clockwise/anti-clockwise	Forward/rewind 30s
Press joystick's top button once	Pause/resume

6. Play Sequence on Wall

Sequence

When connected with the device or platform other than VM and VMS, after selecting the video wall window, press the **Sequence ID+CAM_G** to play the configured sequence on the window, and the image will be switched sequentially at the preset interval.



NOTE!

If there is no split window, sequence will be played in the window; if there are split windows, sequence will start from the first split window.

1. Press the *sequence ID*, and then press the CAM_G key to play the sequence image on the wall.

Platform Mode	
ID: 1	WALL: 1
MON: 1	WIN:
C_G: 1	
PNL:	

2. You can switch the image during sequence.

Key	Function	Key	Function
PREV	Switch to the previous image	NEXT	Switch to the next image

Single-Window Sequence

When connected with VM, after selecting the split window, press **Single-Window Sequence ID+CAM_G** to play the configured single-window sequence on the split-window, and then different IPC image will be switched sequentially at the preset interval.



NOTE!

If there is no split window, please select the window, and single-window sequence will be played in the window; if there are split windows, please select a split-window for single-window sequence.

1. Press the *single-window sequence ID*, and then press the CAM_G key to play the single-window sequence image on the wall.

Platform Mode	
ID: 1	WALL: 1
MON: 1	WIN: 1
C_G: 1	
PNL:	

2. You can switch the image during single-window sequence.

Key	Function	Key	Function
PREV	Switch to the previous image	NEXT	Switch to the next image

7. Window Style

Display Window Border and ID

After selecting the video wall, press the digit 0, and then press the MON key to display/hide the yellow border on the video wall window and window ID.

Platform Mode	
ID: 1	WALL: 1
MON:	WIN:
CAM:	
PNL: S/H WinCode	

Split Window

If there is no split window or you need to re-split the window, after selecting the window, press the number of split windows, and then press the MULT key to split the window.

Platform Mode	
ID: 1	WALL: 1
MON: 1	WIN:
CAM:	
PNL: Mult	

Zoom In/Restore Window/Split Window

If you want to zoom in a specific window/split window, after selecting the video wall, press **Window ID+MON+Split Window ID+WIN+ZOOM** to zoom in or restore the image to the original ration. Steps are as follows:

When connecting the device with different devices, the actual operation and display may varies.

- When connected with VM devices:
 Press **Window ID+MON+1+WIN** to select the window; or press **Window ID+MON+Split Window ID+WIN** to select the split window. Then press the ZOOM+/- key to zoom in or restore the selected window/split window to the original ratio.

Platform Mode	
ID: 1	WALL: 1
MON: 1	WIN:
CAM:	
PNL: Win Amplifi	

Platform Mode	
ID: 1	WALL: 1
MON: 1	WIN:
CAM:	
PNL: Win Recover	

- Zoom in: Zoom the selected window to all channels (full screen); zoom the selected split window to the window.

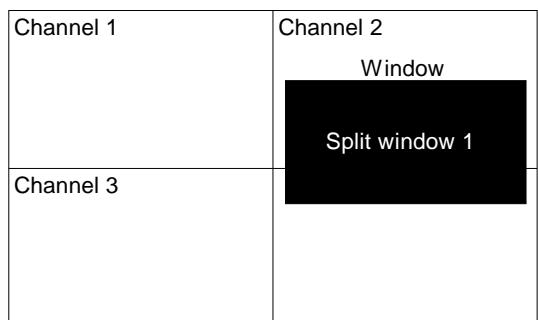
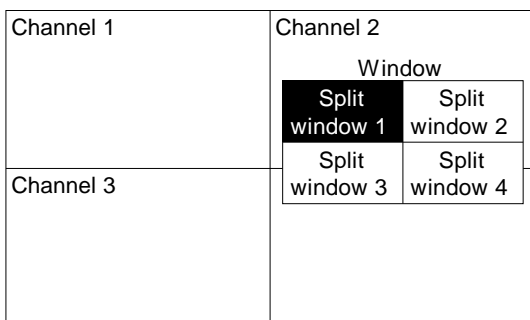
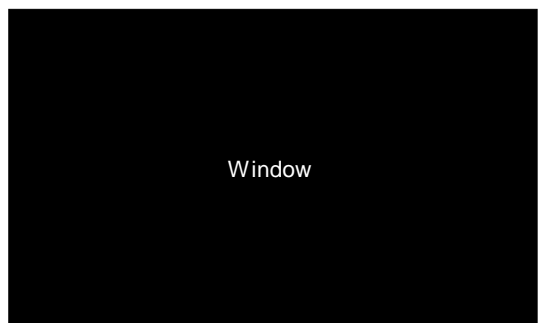
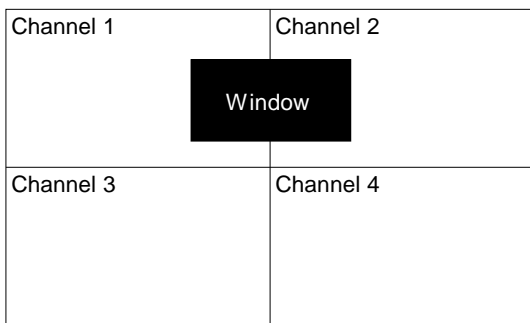

- Restore: Restore the window/split window to the original ratio.
- When connected with the decoding device or platform:
 - Press **Window ID+MON** to select the window; or press **Window ID+MON+Split Window ID+WIN** to select the split window. Then press the ZOOM+/- key to zoom in/restore the window/split window as follows:

Platform Mode	
ID: 1	WALL: 1
MON: 1	WIN:
CAM:	
PNL: Win Amplifi	

Platform Mode	
ID: 1	WALL: 1
MON: 1	WIN:
CAM:	
PNL: Win Recover	

- Zoom in: Zoom the selected window to

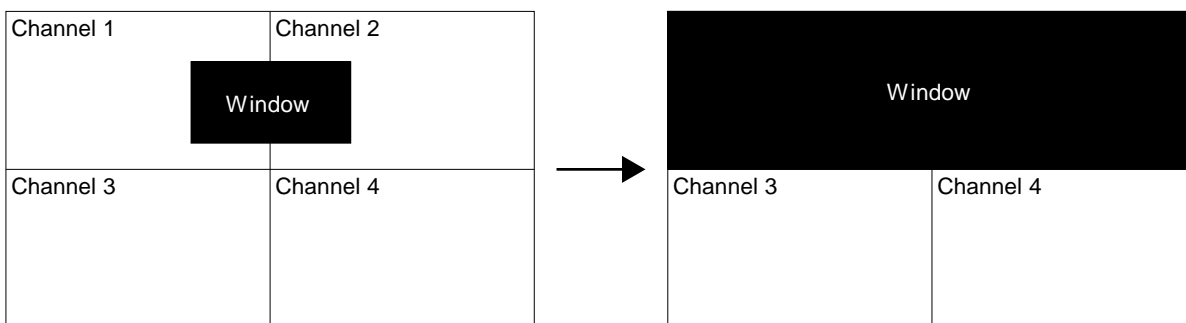

- Restore: Restore the window/split window to the original ratio.